

Elbow 90°

PE 3408/PE 4710/PE 100
Injection molded

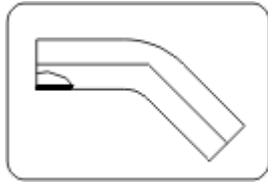

Elbow 45°

PE 3408/PE 4710/PE 100
Injection molded

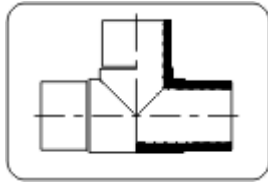

Tee

PE 3408/PE 4710/PE 100
Injection molded

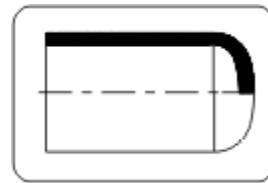

End Cap

PE 3408/PE 4710/PE 100
Injection molded

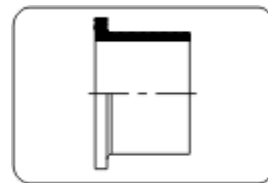

Flange Adaptor

PE 3408/PE 4710/PE 100
Injection molded

Pipe Fittings have long spigots;
Dimensions available from 3/4" – 12".

Pressure Rating 160PSI (SDR 11) or
110PSI (SDR 17).

For further specifications please visit
www.agruamerica.com

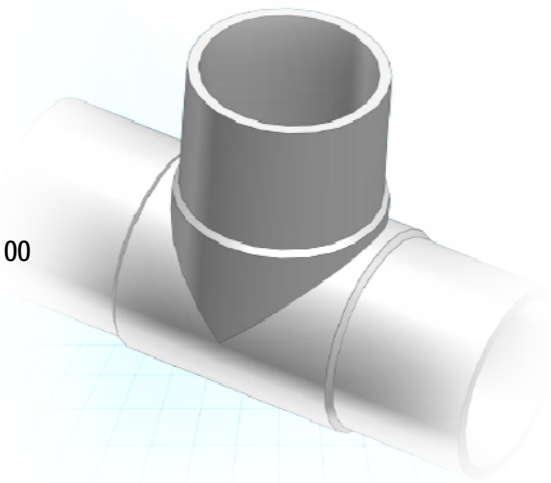

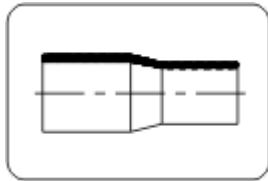

Reducer Concentric

PE 3408/PE 4710/PE 100
Injection molded, long spigot
Dimensions available up to 12"
Pressure Rating 160psi or 110psi

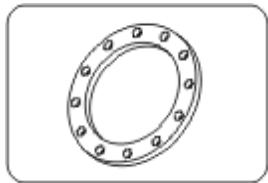

PP Backing Ring

Injection molded with steel insert
Dimensions available from 1/2" to 12", 16 bar

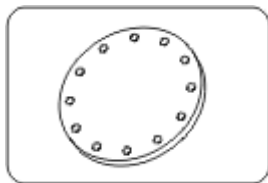

PP Blind Flange

Injection molded with steel insert
Dimensions available from 1/2" to 12", 16 bar

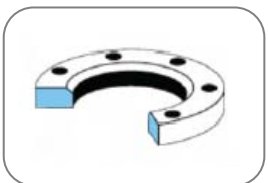

Ductile Iron Backing Rings

Conventional Cross Section in Ductile Iron
Dimensions available from 1" to 12"

New E Coupler!

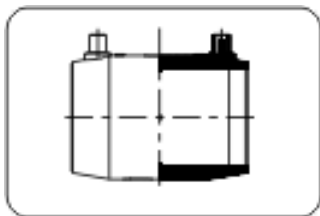

Electro Fusion Coupler

PE 3408/PE4710/PE 100
Injection molded
Smooth inner surface

Dimensions available: 4", 6"
160 PSI

For further specifications please visit:

www.agruamerica.com

